

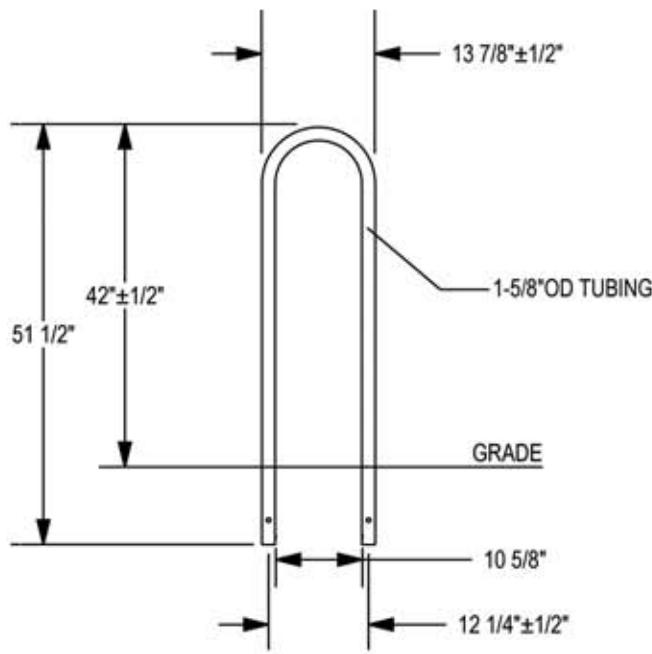

25BR-251S

1 Loop Winder Plus (3 Bikes)
Surface Mount



ELEVATION VIEW

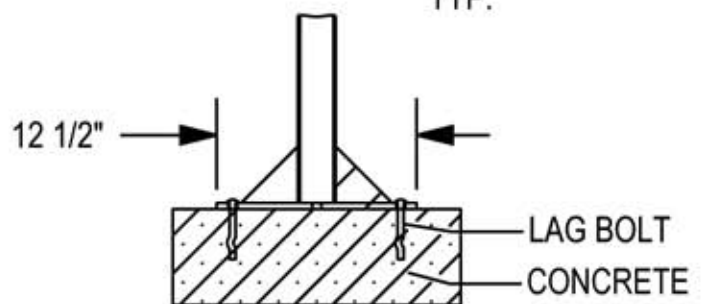
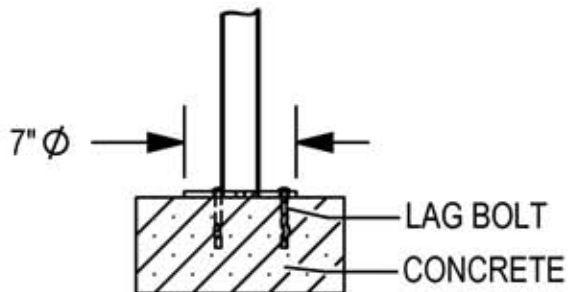
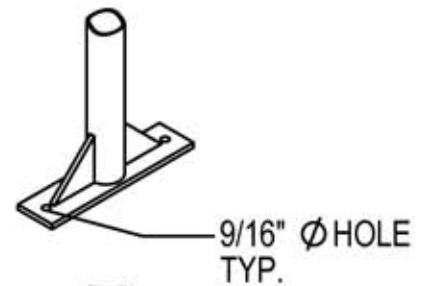
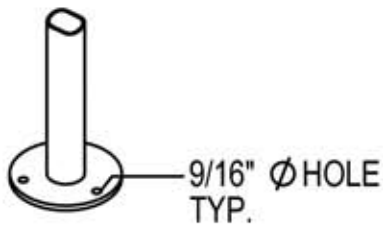

□ SURFACE FLANGE MOUNT (SF)

□ SURFACE GUSSET MOUNT (SG)